

RTG-1802

- SET UP INSTRUCTIONS:**
1. CONNECT BOTTOM AND TOP TUBES FOLLOWING THE LABELS
 2. CONNECT SIDE TUBES
 3. CLEAN THE FRAME AND PLACE THEM ON CLEAN PLACE
 4. CAREFULLY REMOVE FABRIC COVER FROM BAG
 5. PLACE COVER AROUND THE BOTTOM OF THE FRAME
 6. PULL COVER CAREFULLY UP TO THE TOP
 7. CLOSE ALL ZIPPERS
 8. ADJUST FABRIC AROUND THE FRAME
 9. CONNECT CABLE HARNESS TO THE EYEBOLTS
 10. COMPLETELY TIGHTEN THREADED CONNECTORS

BREAK DOWN INSTRUCTIONS:
REVERSE SET-UP STEPS TO BREAKDOWN FRAME

- FABRIC CARE INSTRUCTIONS:**
1. UNZIP COVER ZIPPERS
 2. CAREFULLY REMOVE FABRIC COVER
 3. CLOSE ALL ZIPPERS
 4. FOLD OR ROLL NEATLY
 5. PLACE FABRIC IN COVER BAG

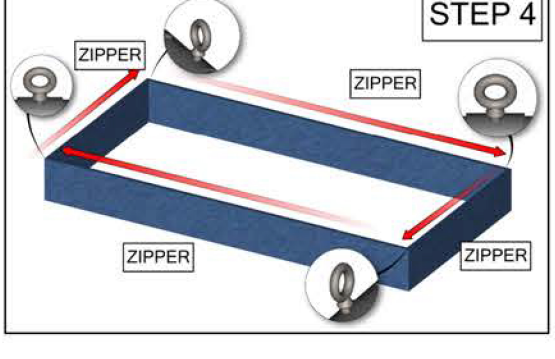
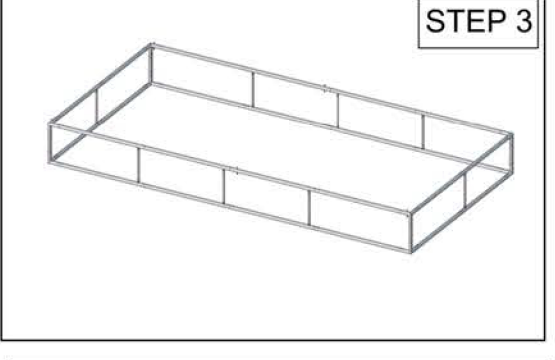
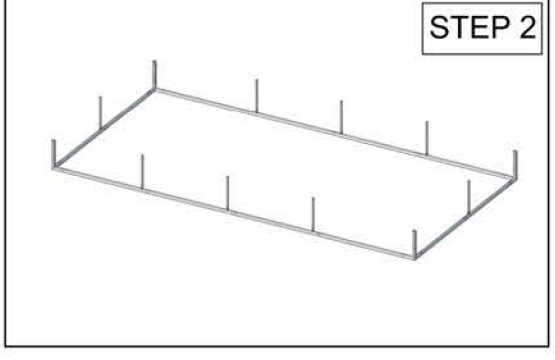
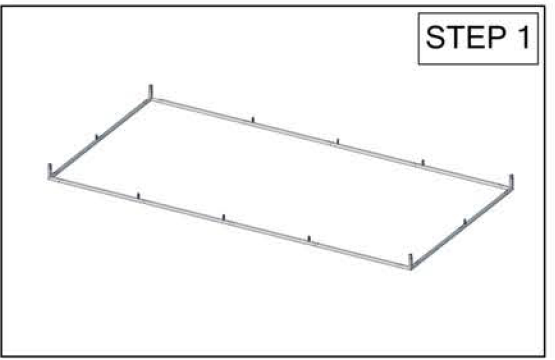
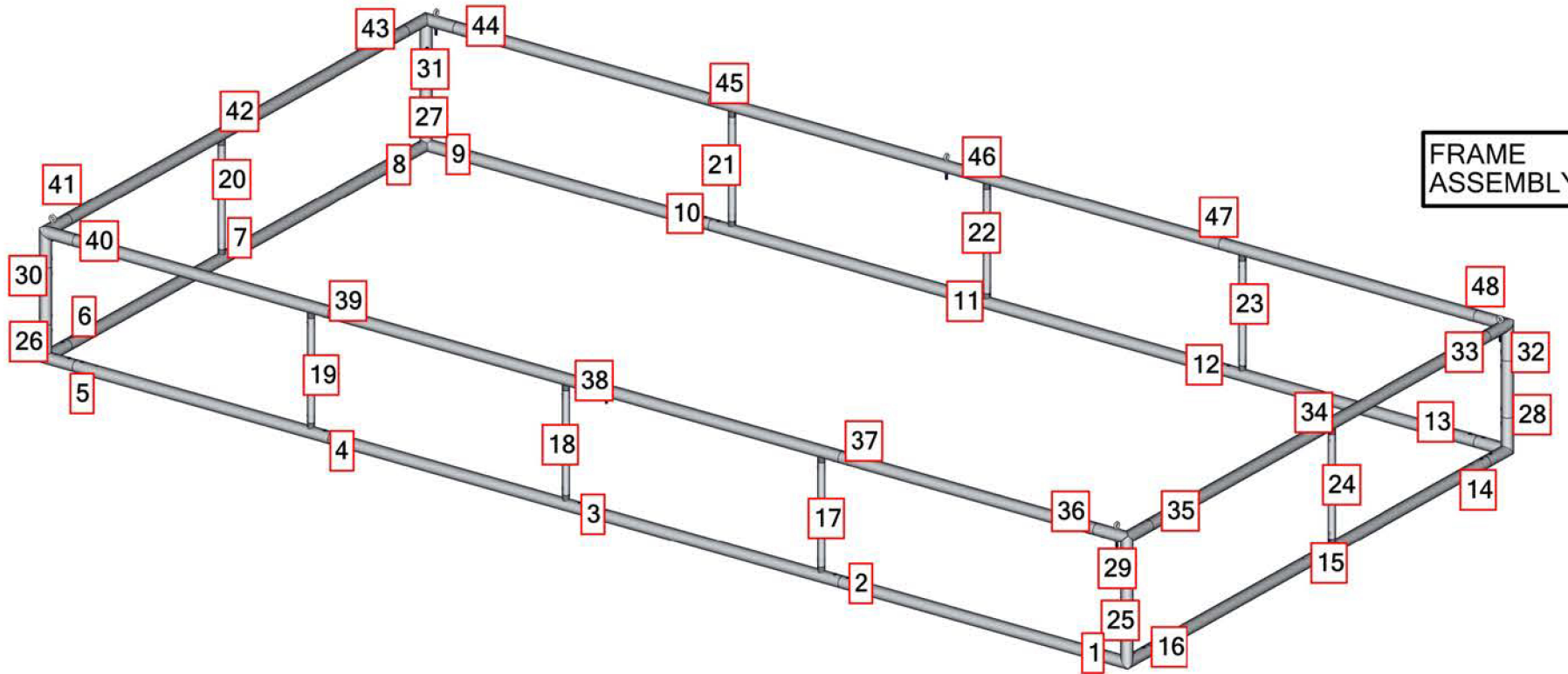

TOTAL WEIGHT: 124.4 (lbs)
MAX SIZE: 59.3 (in)
HARDWARE: 99.5 (lbs)
GRAPHIC: 15.0 (lbs)

QTY	CODE	DESCRIPTION
6	EYE BOLT	5/16-18X3.125" PARTIALLY THREADED EYE BOLT FOR 2" TUBING FABRIC STRUCTURES
8	CORNER-50-90°	3 WAY WELDED CORNER MADE FROM 2" TUBING (90°)
6	HD-10	120" LENGTH 1/8" 7X7 GALVANIZED STEEL CABLE NATURAL VINYL COATED TO 3/16" OD
16	RTG-18-T1	TUBE 1 FOR 18' RECTANGULAR HANGING FABRIC STRUCTURES
8	RTG-18-T2	TUBE 2 FOR 18' RECTANGULAR HANGING FABRIC STRUCTURES
8	SPDR-30-S2-2	30MM STRAIGHT SPREADER FOR 50MM CONNECTIONS OF 2' STRUCTURES
4	SPDR-50-S2-2	2" TUBING SPREADER FOR 2' HIGH FOR FOUR SIDED HANGING FABRIC STRUCTURES

