

TRI-1004

SET UP INSTRUCTIONS:

1. CONNECT BOTTOM AND TOP TUBES FOLLOWING THE LABELS
2. CONNECT SIDE TUBES
3. CLEAN THE FRAME AND PLACE THEM ON CLEAN PLACE
4. CAREFULLY REMOVE FABRIC COVER FROM BAG
5. PLACE COVER AROUND THE BOTTOM OF THE FRAME
6. PULL COVER CAREFULLY UP TO THE TOP
7. CLOSE ALL ZIPPERS
8. ADJUST FABRIC AROUND THE FRAME
9. CONNECT CABLE HARNESS TO THE EYEBOLTS
10. COMPLETELY TIGHTEN THREADED CONNECTORS

BREAK DOWN INSTRUCTIONS:

REVERSE SET-UP STEPS TO BREAKDOWN FRAME

FABRIC CARE INSTRUCTIONS:

1. UNZIP COVER ZIPPERS
2. CAREFULLY REMOVE FABRIC COVER
3. CLOSE ALL ZIPPERS
4. FOLD OR ROLL NEATLY
5. PLACE FABRIC IN COVER BAG

TOTAL WEIGHT: 40.9(lbs)
 MAX SIZE: 55.9(in)
 HARDWARE: 22.0(lbs)
 GRAPHIC: 16.6(lbs)

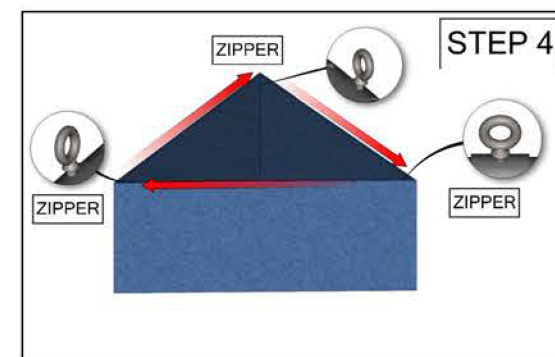
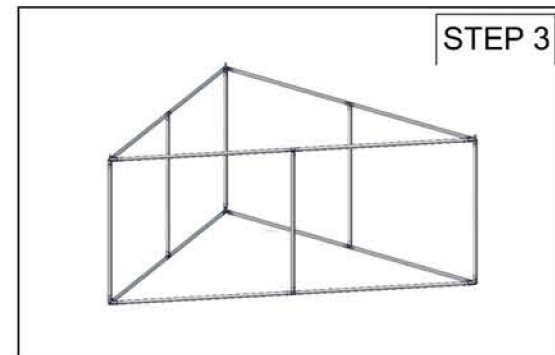
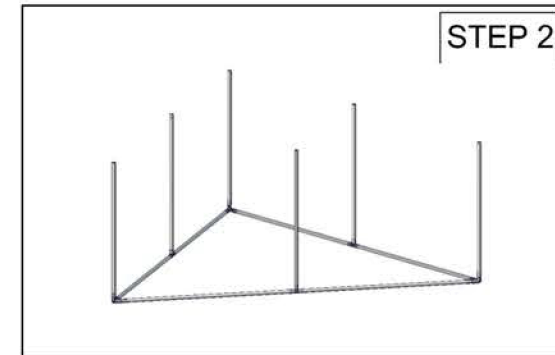
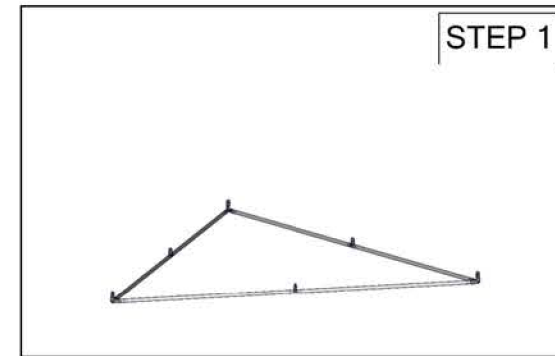
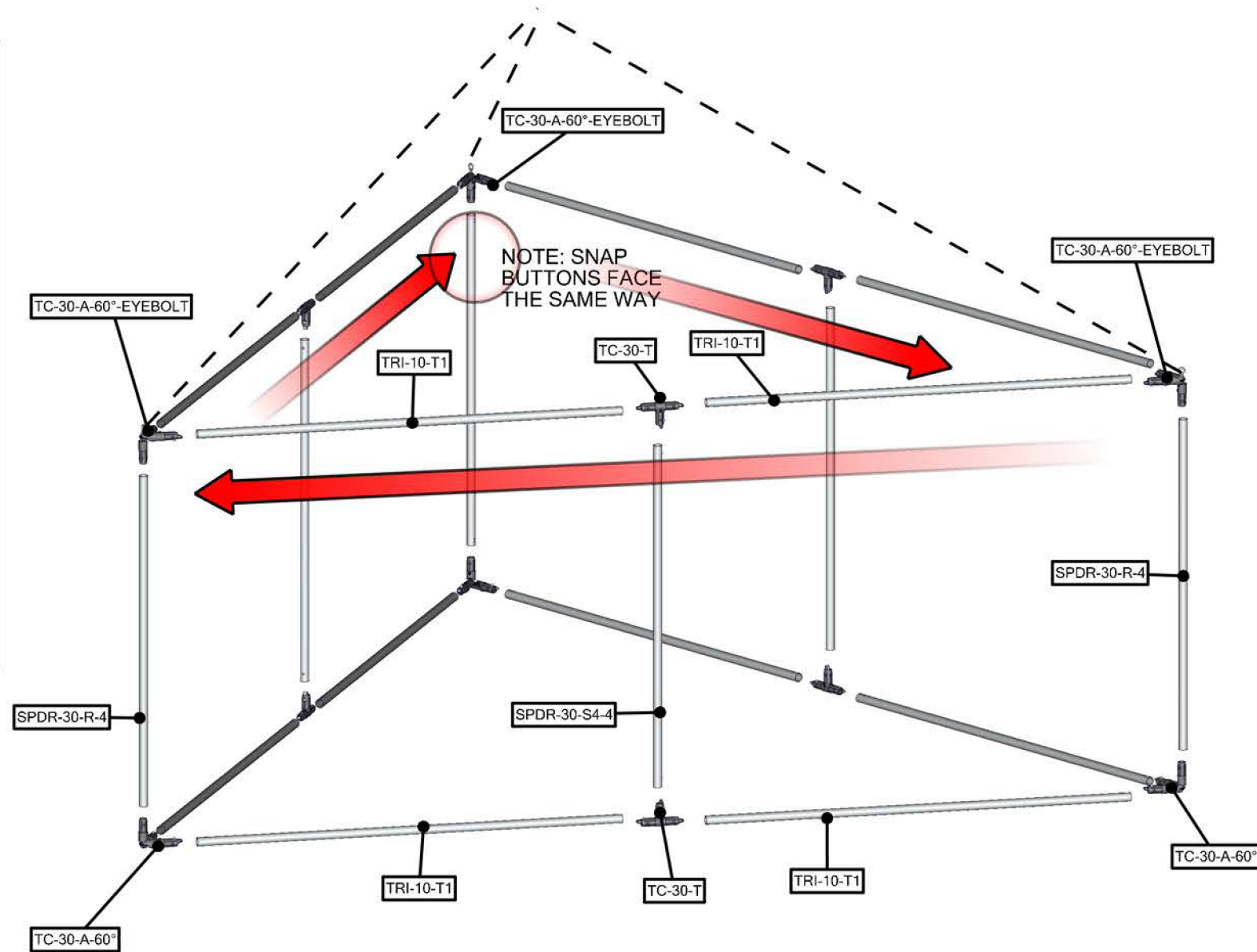

QTY	CODE	DESCRIPTION
3	SPDR-30-R-4	30MM STRAIGHT SPREADER FOR CORNERS OF 4' STRUCTURES USING RIVETS
3	SPDR-30-S4-4	30MM STRAIGHT SPREADER FOR CORNERS TO TC-30-90T JUNCTIONS OF 4' STRUCTURES USING RIVETS
3	TC-30-A-60°-EYEBOLT	TC-30-A ASSEMBLED at 60° WITH 1/4-20 EYE BOLT
3	TC-30-A-60°	TC-30-A ASSEMBLED at 60°
6	TC-30-T	T JUNCTION FOR 30MM TUBING
12	TRI-10-T1	TUBE 1 FOR 10' TRIANGLE HANGING FABRIC STRUCTURE

