

RNG-1402

FRAME ASSEMBLY

- SET UP INSTRUCTIONS:**
1. CONNECT BOTTOM AND TOP TUBES FOLLOWING THE LABELS
 2. CONNECT SIDE TUBES
 3. CLEAN THE FRAME AND PLACE THEM ON CLEAN PLACE
 4. CAREFULLY REMOVE FABRIC COVER FROM BAG
 5. PLACE COVER AROUND THE BOTTOM OF THE FRAME
 6. PULL COVER CAREFULLY UP TO THE TOP
 7. CLOSE ALL ZIPPERS
 8. ADJUST FABRIC AROUND THE FRAME
 9. CONNECT CABLE HARNESS TO THE EYEBOLTS
 10. COMPLETELY TIGHTEN THREADED CONNECTORS

- BREAK DOWN INSTRUCTIONS:**
REVERSE SET-UP STEPS TO BREAKDOWN FRAME

- FABRIC CARE INSTRUCTIONS:**
1. UNZIP COVER ZIPPERS
 2. CAREFULLY REMOVE FABRIC COVER
 3. CLOSE ALL ZIPPERS
 4. FOLD OR ROLL NEATLY
 5. PLACE FABRIC IN COVER BAG

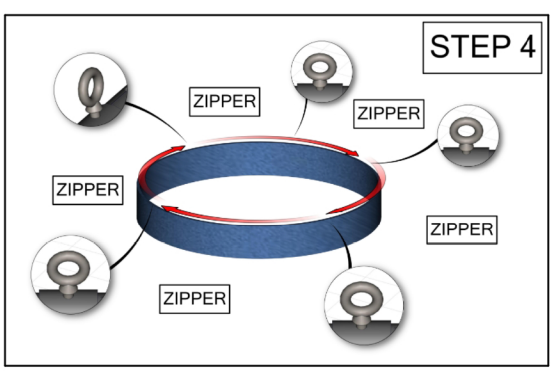
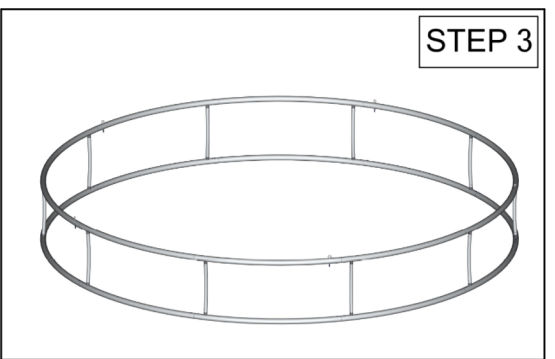
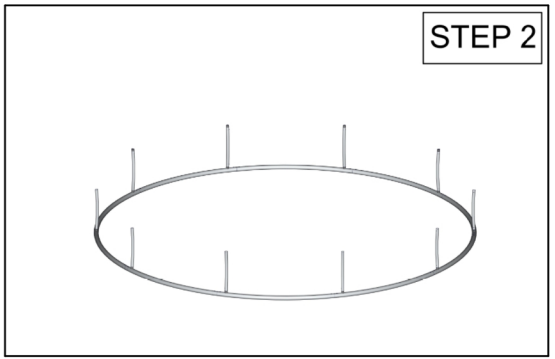
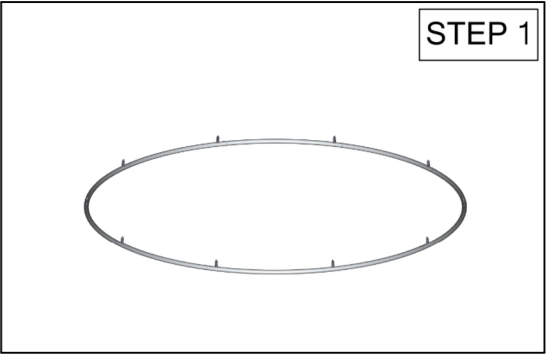
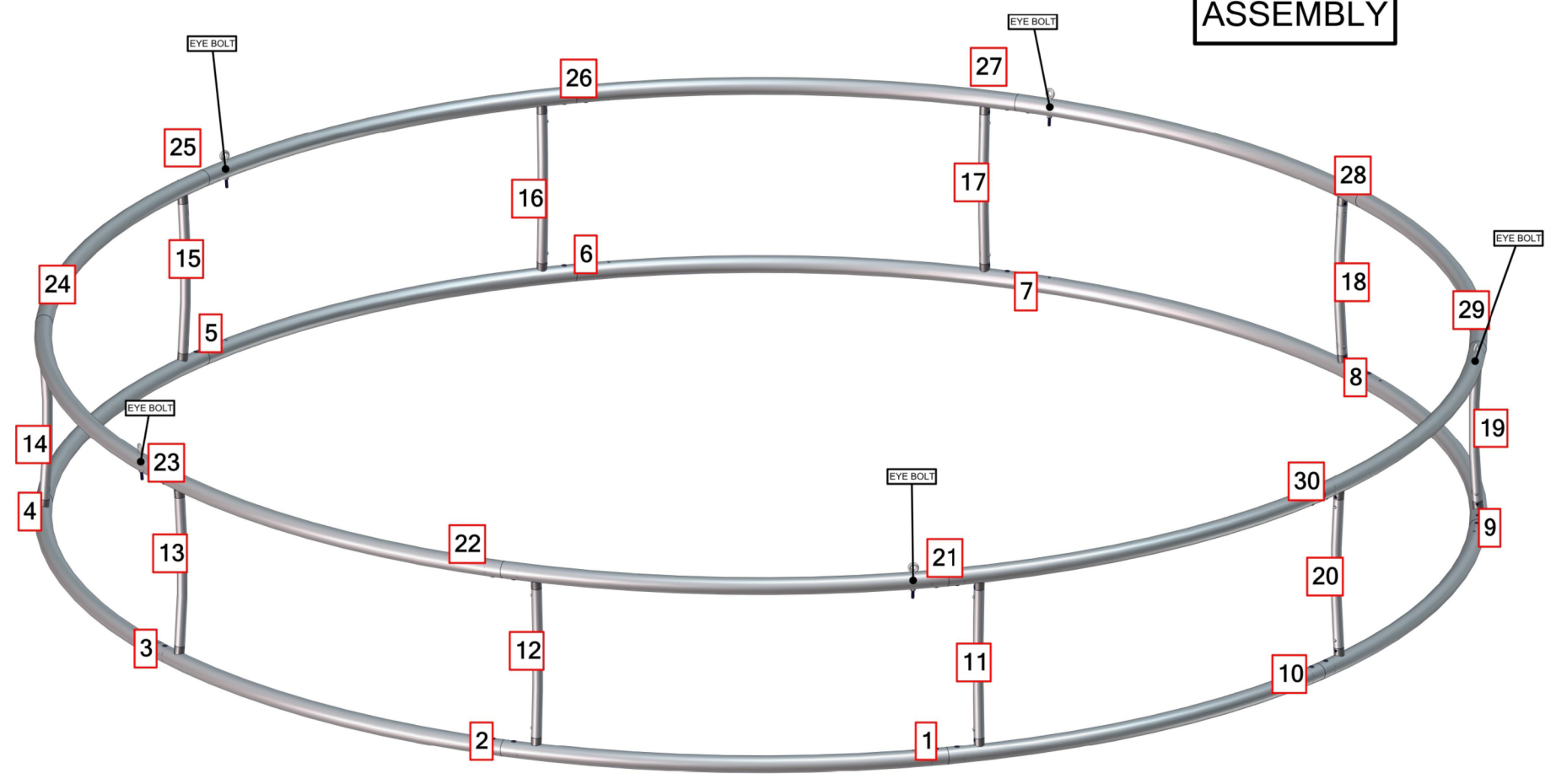

TOTAL WEIGHT: 89.1 (lbs)
MAX SIZE: 51.9 (in)
HARDWARE: 69.9 (lbs)
GRAPHIC: 12.2 (lbs)

QTY	CODE	DESCRIPTION
5	EYE BOLT	5/16-18X3.125" PARTIALLY THREADED EYE BOLT FOR 2" TUBING FABRIC STRUCTURES
1	CH-SP5-HD-12	5-CABLE SINGLE POINT HEAVY DUTY HARNESS WITH 144" LENGTHS 1/8" CABLE
20	ES-50	EXPANDING SPIGOT FOR 50MM TUBE
20	RNG-14-T1	50MM TUBE1 FOR 14' DIAMETER RING
10	SPDR-30-S11-2	30MM CURVED SPREADER FOR 50MM CONNECTIONS OF 2' STRUCTURES

